

PRESCRIBING INFORMATION

SelectBag One

Solution for Dialysis

Baxter Corporation
Mississauga, Ontario L5N 0C2
Canada

Date of Revision:
JUN 10, 2021

Submission Control No: 247855

Baxter, Gambro, BiCart Select and SelectBag are trademarks of Baxter International Inc., or its subsidiaries.

SelectBag One

DESCRIPTION

The SelectBag One product is a low-density polyethylene (LDPE) container containing a highly concentrated dialysis concentrate of the minor electrolytes (e.g. KCl, CaCl₂, MgCl₂) and acid needed in a bicarbonate- based dialysis fluid.

When the product is attached to the specially designed container holder and the spike is inserted into the container, the concentrate is drawn out by the dialysis machine.

The dialysis machine mixes the acidic concentrate with the sodium chloride concentrate and the sodium bicarbonate concentrate to produce a bicarbonate-based dialysis fluid.

Free from bacterial endotoxins.

INDICATIONS

To be used in a bicarbonate dialysis treatment for patients suffering from acute renal failure, chronic renal failure or acute intoxication with dialysable substances.

Intended Use

The SelectBag One product is intended to be used as an acetic acid based concentrate together with the BiCart Select combi-pak for on-line preparation of haemodialysis, haemodiafiltration or haemofiltration fluids on compatible Gambro dialysis systems.

SPECIFICATIONS

Contents

1000 mL dialysis concentrate

Please refer to the product label for the exact composition.

Capacity

Diluted 1:200, 200 litres of dialysis fluid can be produced.

Requirements for mixing

The dialysis concentrate must be mixed with a pure sodium chloride concentrate and a pure sodium bicarbonate concentrate, on a specially adapted dialysis machine to obtain the final dialysis fluid composition. Please refer to page 6.

As an example, when the SelectBag One AX 250 G concentrate is mixed with a dilution ratio of 1:200, this yields the following in mmol/L:

Potassium	2	Chloride	6
Calcium	1.5	Acetate	3
Magnesium	0.5	Glucose	5.55

Together with the sodium chloride concentrate and sodium bicarbonate concentrate from the BiCart Select combi-pak, the final dialysis fluid will have a sodium level of 140 mmol/L and a bicarbonate level of 34 mmol/L, at a normal machine setting.

However, if the sodium and/or bicarbonate set levels on the machine are changed then only these concentration levels will be modified. The potassium, calcium and magnesium levels will not be altered.

Requirements for water

Dialysis machine inlet water: Inlet water quality must comply with local regulations and, if no such regulations are available, follow ISO 13959.

CAUTIONS

The information in this document must be carefully read and understood before using the SelectBag One product.

The concentrate in the SelectBag One container must be used within 24 hours after opening.

This product is for single use only. Any unused solution to be discarded.

When the container is empty it shall be discarded according to local regulations.

The product must only be used with dialysis machines which are specially adapted¹ for receiving the SelectBag One container.

This package leaflet must always be used together with the operator's manual of the corresponding dialysis machine which describes the handling instructions in detail.

The operation of the specially adapted dialysis machine is restricted to persons who are trained in dialysis and who are completely familiar with the operating instructions stated in the operator's manual of the corresponding dialysis machine and in this package leaflet.

The concentrate has a pH of about 2. The BiCart Select system is designed to minimize the risks associated with handling of such concentrates. However, if the concentrate comes in personal contact, specific first aid recommendations should be followed as described under FIRST AID.

WARNINGS

DO NOT use if any damage is found or suspected.

DO NOT use any other type of sodium chloride (NaCl) concentrate and sodium bicarbonate (NaHCO₃) concentrate than the type specified under INDICATIONS and SPECIFICATION.

DO NOT initiate dialysis without having followed the instructions in the Operator's manual of the corresponding dialysis machine regarding any recommended tests to verify the proper composition of the dialysis fluid.

DO NOT use with dialysis machines that are not specially adapted for receiving the SelectBag One container.

DO NOT perform any unauthorized modifications or alterations to the products or to the dialysis machine as this may result in a malfunction or have other serious consequences on the safe operation of the dialysis treatment.

FIRST AID

Skin contact: Rinse with water.

Eye contact: Rinse continuously with water for several minutes. Remove contact lenses, if present and easy to do. Continue rinsing. If irritation remains, contact a physician.

Ingestion: Wash mouth with water and drink water or milk. Do not induce vomiting. If irritation remains, contact a physician.

CONTRAINDICATIONS

There are no absolute contraindications for bicarbonate dialysis. The SelectBag One concentrate must be used only on the direction of a physician who has evaluated all the pertinent features of the product in relation to the individual patient.

ADVERSE REACTIONS

Some undesirable effects related to dialysis can occur, for instance hypotension, nausea, vomiting and cramps.

HANDLING INSTRUCTIONS

Please refer to pages 7-10. Wear eye protection if there is a risk of splash.

STORAGE AND SHELF LIFE

Storage

Store between +15°C (+59°F) and +25°C (+77°F).

Shelf life

Refer to the expiry date stated on the product label.

WARRANTY AND LIMITATIONS OF LIABILITY

a) The manufacturer warrants that the SelectBag One product has been manufactured in accordance with its specifications and in compliance with Good Manufacturing Practices, other applicable industry standards and regulatory requirements.

If provided with the lot number of the defective product, the manufacturer will, by replacement only, remedy manufacturing defects in the product becoming apparent within six (6) month from the date of delivery to the customer.

b) The warranty under paragraph a) above is in lieu of, and to the exclusion of, any other warranty, whether written or oral, expressed or implied, statutory or otherwise, and there are no warranties of merchantability, fitness for a particular purpose, or other warranties, which extended beyond those described in paragraph a) above. The remedy set out above for manufacturing defects is the sole remedy available to any person due to defects in the product and the manufacturer shall not be liable for any consequential or incidental loss, damage, injury, or expense arising directly or indirectly from the use of the product, whether as a result of any defect therein or otherwise.

c) The manufacturer shall not be liable for any misuse, improper handling, non compliance with warnings and Instructions, damage arising from events after the manufacturer's release of the product, failure or omission to inspect the product before use in order to insure that the product is in proper condition, or any warranty given by independent distributors or dealers.

¹The SelectBag One container holder of a specially adapted dialysis machine is marked 1000 mL. Please refer to pictures on pages 7-10.

Chemical Composition

	Na ⁺ mmol/L	K ⁺ mmol/L	Ca ²⁺ mmol/L	Mg ²⁺ mmol/L	Cl ⁻ mmol/L	CH ₃ COO ⁻ mmol/L	C ₆ H ₁₂ O ₆ mmol/L	HCO ₃ ⁻ mmol/L
AX 050 G	140	0	1.5	0.5	107	3	5.55	34
AX 125 G	140	1	1.25	0.5	107.5	3	5.55	34
AX 150 G	140	1	1.5	0.5	108	3	5.55	34
AX 200 G	140	2	1	0.5	108	3	5.55	34
AX 225 G	140	2	1.25	0.5	108.5	3	5.55	34
AX 250 G	140	2	1.5	0.5	109	3	5.55	34
AX 275 G	140	2	1.75	0.5	109.5	3	5.55	34
AX 2525 G	140	2.5	1.25	0.5	109	3	5.55	34
AX 2550 G	140	2.5	1.5	0.5	109.5	3	5.55	34
AX 325 G	140	3	1.25	0.5	109.5	3	5.55	34
AX 350 G	140	3	1.5	0.5	110	3	5.55	34
AX 450 G	140	4	1.5	0.5	111	3	5.55	34

The table shows the electrolyte composition in ready to use solution, when mixed with the solutions from the BiCart Select combi-pak cartridges, and with the default machine settings Na⁺ 140 mmol/L and HCO₃⁻ 34 mmol/L.

Connection



(1.) Open the cap lid.

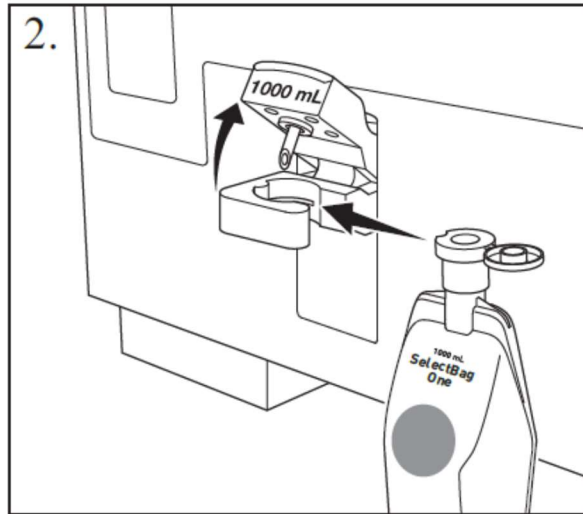

(2.) Pull out the holder, open the latch and place the product in the holder's seat.

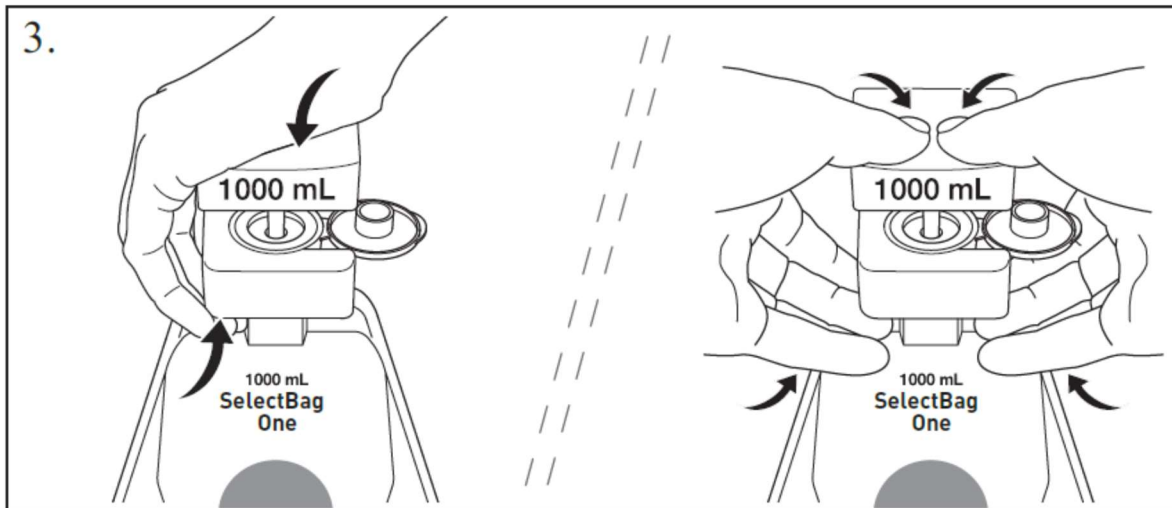

(3.) Press the latches firmly together so the spike penetrates the membrane completely with a one or two hands grip.

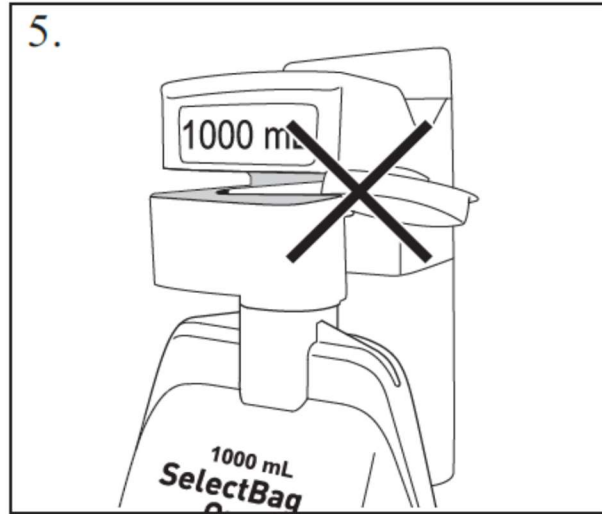
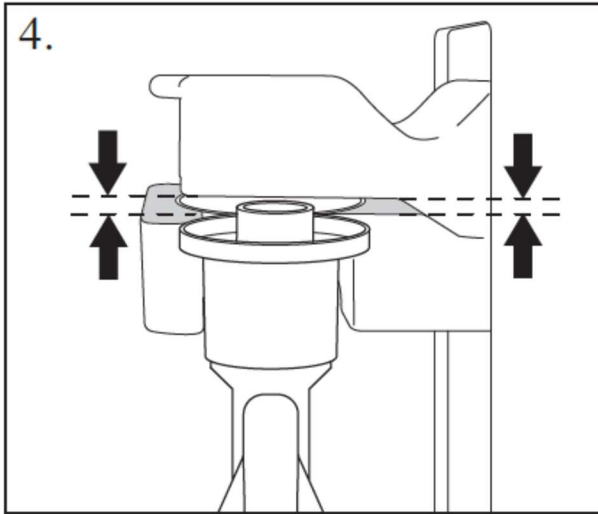

(4-5.) Make sure that the latches are pressed together and in a horizontal position and that the latches do not squeeze the cap lid.

Disconnection

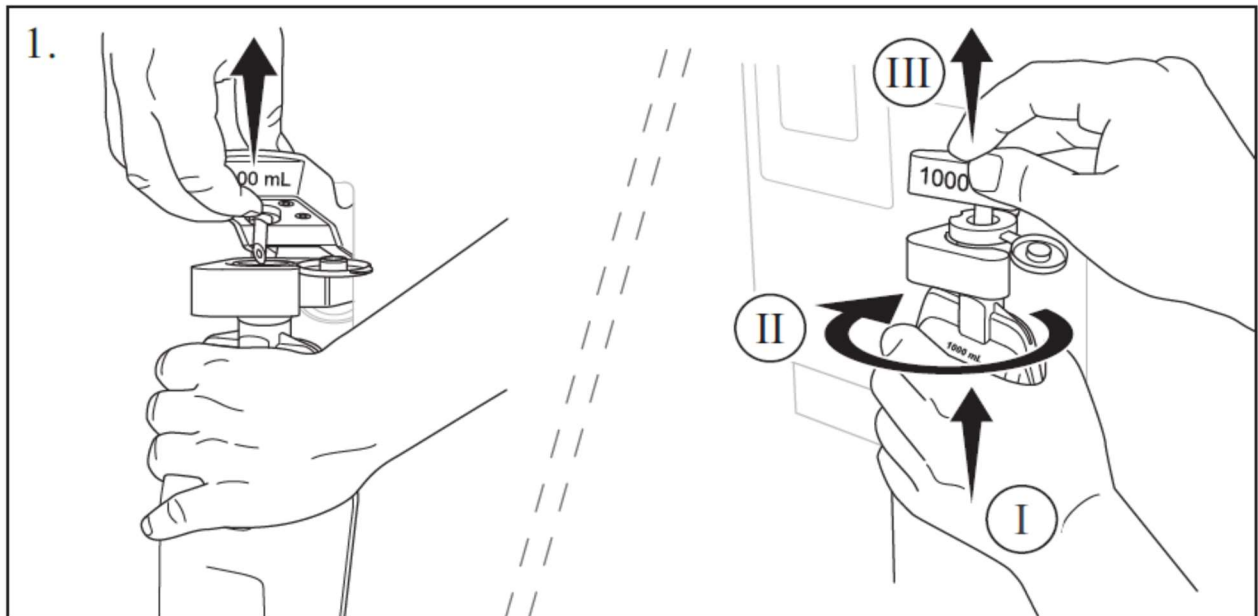

(1.) Hold the product in the upper part and open the latch OR hold the product in the upper part, (I) push and (II) twist the product upwards and (III) open the latch.

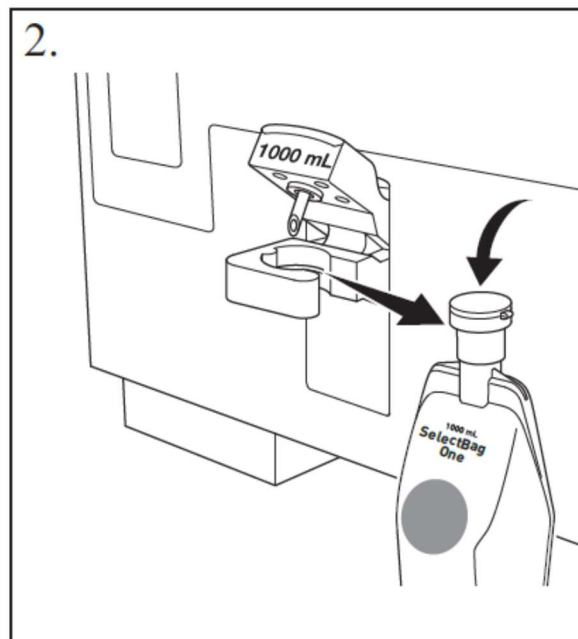

(2.) Remove the product and close the cap lid, be careful to avoid spillages and splashes.

Reconnection

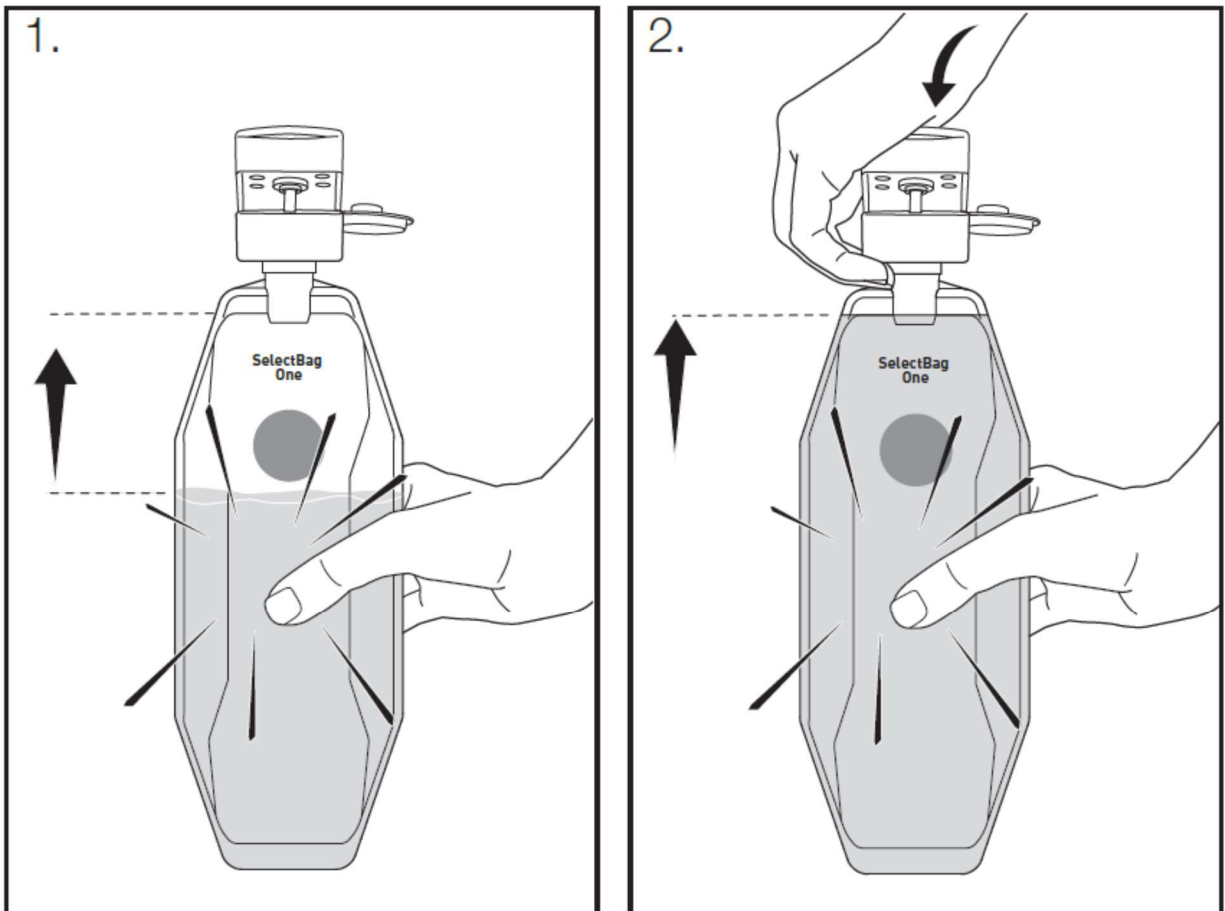

Reconnection: (1.) Place the product in the holder and raise the solution level to the upper part of the container, be careful to avoid spillages and splashes. (2.) Hold the level and connect the product. Reminder: This product is for single use only.

Baxter Corporation

Mississauga, ON L5N 0C2

Baxter, Gambro, BiCart Select and SelectBag are trademarks of Baxter International Inc., or its subsidiaries.

Last revised: JUN 10, 2021